

IRF7342QPbF

HEXFET® Power MOSFET

- Advanced Process Technology
- Ultra Low On-Resistance
- Dual P Channel MOSFET
- Surface Mount
- Available in Tape & Reel
- 150°C Operating Temperature
- Automotive [Q101] Qualified
- Lead-Free

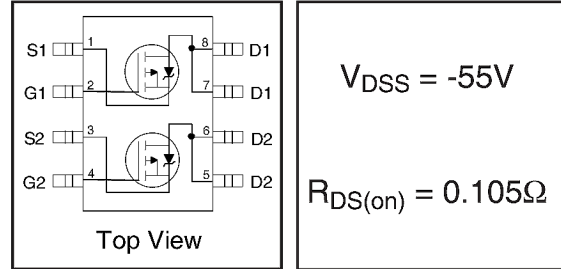

Description

Specifically designed for Automotive applications, these HEXFET® Power MOSFET's in a Dual SO-8 package utilize the latest processing techniques to achieve extremely low on-resistance per silicon area. Additional features of these Automotive qualified HEXFET Power MOSFET's are a 150°C junction operating temperature, fast switching speed and improved repetitive avalanche rating. These benefits combine to make this design an extremely efficient and reliable device for use in Automotive applications and a wide variety of other applications.

The efficient SO-8 package provides enhanced thermal characteristics and dual MOSFET die capability making it ideal in a variety of power applications. This dual, surface mount SO-8 can dramatically reduce board space and is also available in Tape & Reel.

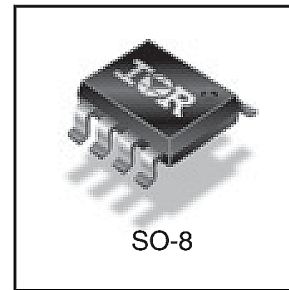

Absolute Maximum Ratings

| | Parameter | Max. | Units |
|--------------------------|---|--------------|------------|
| V_{DS} | Drain- Source Voltage | -55 | V |
| $I_D @ T_C = 25^\circ C$ | Continuous Drain Current, $V_{GS} @ 10V$ | -3.4 | A |
| $I_D @ T_C = 70^\circ C$ | Continuous Drain Current, $V_{GS} @ 10V$ | -2.7 | |
| I_{DM} | Pulsed Drain Current ① | -27 | |
| $P_D @ T_C = 25^\circ C$ | Power Dissipation | 2.0 | W |
| $P_D @ T_C = 70^\circ C$ | Power Dissipation | 1.3 | |
| | Linear Derating Factor | 0.016 | |
| V_{GS} | Gate-to-Source Voltage | ± 20 | V |
| V_{GSM} | Gate-to-Source Voltage Single Pulse $t_p < 10\mu s$ | 30 | V |
| E_{AS} | Single Pulse Avalanche Energy ② | 114 | |
| dv/dt | Peak Diode Recovery dv/dt ③ | 5.0 | V/ns |
| T_J, T_{STG} | Junction and Storage Temperature Range | -55 to + 150 | $^\circ C$ |

Thermal Resistance

| | Parameter | Typ. | Max. | Units |
|-----------------|-------------------------------|------|------|--------------|
| $R_{\theta JA}$ | Maximum Junction-to-Ambient ⑤ | — | 62.5 | $^\circ C/W$ |

IRF7342QPbF

International
 Rectifier

Electrical Characteristics @ $T_J = 25^\circ\text{C}$ (unless otherwise specified)

| | Parameter | Min. | Typ. | Max. | Units | Conditions |
|---------------------------------|--------------------------------------|------|--------|-------|----------|---|
| $V_{(BR)DSS}$ | Drain-to-Source Breakdown Voltage | -55 | — | — | V | $V_{GS} = 0V, I_D = -250\mu A$ |
| $\Delta V_{(BR)DSS}/\Delta T_J$ | Breakdown Voltage Temp. Coefficient | — | -0.054 | — | V/°C | Reference to 25°C , $I_D = -1\text{mA}$ |
| $R_{DS(on)}$ | Static Drain-to-Source On-Resistance | — | 0.095 | 0.105 | Ω | $V_{GS} = -10V, I_D = -3.4A$ ④ |
| | | — | 0.150 | 0.170 | | $V_{GS} = -4.5V, I_D = -2.7A$ ④ |
| $V_{GS(th)}$ | Gate Threshold Voltage | -1.0 | — | — | V | $V_{DS} = V_{GS}, I_D = -250\mu A$ |
| g_{fs} | Forward Transconductance | 3.3 | — | — | S | $V_{DS} = -10V, I_D = -3.1A$ |
| I_{DSS} | Drain-to-Source Leakage Current | — | — | -2.0 | μA | $V_{DS} = -55V, V_{GS} = 0V$ |
| | | — | — | -25 | | $V_{DS} = -55V, V_{GS} = 0V, T_J = 55^\circ\text{C}$ |
| I_{GSS} | Gate-to-Source Forward Leakage | — | — | -100 | nA | $V_{GS} = -20V$ |
| | Gate-to-Source Reverse Leakage | — | — | 100 | | $V_{GS} = 20V$ |
| Q_g | Total Gate Charge | — | 26 | 38 | nC | $I_D = -3.1A$ |
| Q_{gs} | Gate-to-Source Charge | — | 3.0 | 4.5 | | $V_{DS} = -44V$ |
| Q_{gd} | Gate-to-Drain ("Miller") Charge | — | 8.4 | 13 | | $V_{GS} = -10V$, See Fig. 10 ④ |
| $t_{d(on)}$ | Turn-On Delay Time | — | 14 | 22 | ns | $V_{DD} = -28V$ |
| t_r | Rise Time | — | 10 | 15 | | $I_D = -1.0A$ |
| $t_{d(off)}$ | Turn-Off Delay Time | — | 43 | 64 | | $R_G = 6.0\Omega$ |
| t_f | Fall Time | — | 22 | 32 | | $R_D = 16\Omega$, ④ |
| C_{iss} | Input Capacitance | — | 690 | — | pF | $V_{GS} = 0V$ |
| C_{oss} | Output Capacitance | — | 210 | — | | $V_{DS} = -25V$ |
| C_{rss} | Reverse Transfer Capacitance | — | 86 | — | | $f = 1.0\text{MHz}$, See Fig. 9 |

Source-Drain Ratings and Characteristics

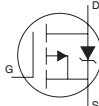
| | Parameter | Min. | Typ. | Max. | Units | Conditions |
|----------|---|------|------|------|-------|--|
| I_S | Continuous Source Current (Body Diode) | — | — | -2.0 | A | MOSFET symbol showing the integral reverse p-n junction diode.  |
| I_{SM} | Pulsed Source Current (Body Diode) ① | — | — | -27 | | |
| V_{SD} | Diode Forward Voltage | — | — | -1.2 | V | $T_J = 25^\circ\text{C}, I_S = -2.0A, V_{GS} = 0V$ ③ |
| t_{rr} | Reverse Recovery Time | — | 54 | 80 | ns | $T_J = 25^\circ\text{C}, I_F = -2.0A$ |
| Q_{rr} | Reverse Recovery Charge | — | 85 | 130 | nC | $di/dt = -100A/\mu s$ ③ |

Notes:

① Repetitive rating; pulse width limited by max. junction temperature. (See fig. 11)

② Starting $T_J = 25^\circ\text{C}$, $L = 20\text{mH}$
 $R_G = 25\Omega$, $I_{AS} = -3.4A$. (See Figure 8)

③ $I_{SD} \leq -3.4A$, $di/dt \leq -150A/\mu s$, $V_{DD} \leq V_{(BR)DSS}$,
 $T_J \leq 150^\circ\text{C}$

④ Pulse width $\leq 300\mu s$; duty cycle $\leq 2\%$.

⑤ When mounted on 1 inch square copper board, $t < 10$ sec

IRF7342QPbF

SO-8 Package Outline

Dimensions are shown in millimeters (inches)

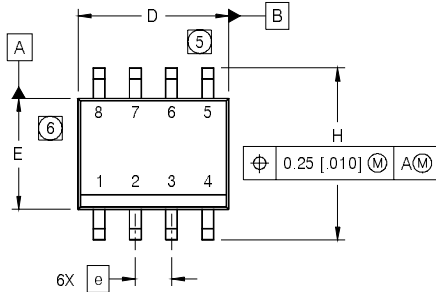

| DIM | INCHES | | MILLIMETERS | |
|-----|------------|-------|-------------|------|
| | MIN | MAX | MIN | MAX |
| A | .0532 | .0688 | 1.35 | 1.75 |
| A1 | .0040 | .0098 | 0.10 | 0.25 |
| b | .013 | .020 | 0.33 | 0.51 |
| c | .0075 | .0098 | 0.19 | 0.25 |
| D | .189 | .1968 | 4.80 | 5.00 |
| E | .1497 | .1574 | 3.80 | 4.00 |
| e | .050 BASIC | | 1.27 BASIC | |
| e1 | .025 BASIC | | 0.635 BASIC | |
| H | .2284 | .2440 | 5.80 | 6.20 |
| K | .0099 | .0196 | 0.25 | 0.50 |
| L | .016 | .050 | 0.40 | 1.27 |
| y | 0° | 8° | 0° | 8° |

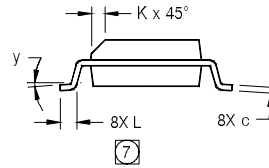
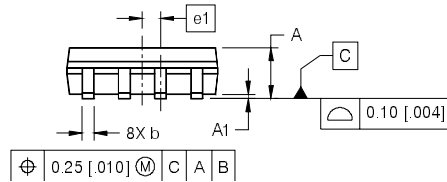

NOTES:

- DIMENSIONING & TOLERANCING PER ASME Y14.5M-1994.
- CONTROLLING DIMENSION: MILLIMETER
- DIMENSIONS ARE SHOWN IN MILLIMETERS [INCHES].
- OUTLINE CONFORMS TO JEDEC OUTLINE MS-012AA.
- ⑤** DIMENSION DOES NOT INCLUDE MOLD PROTRUSIONS. MOLD PROTRUSIONS NOT TO EXCEED 0.15 [.006].
- ⑥** DIMENSION DOES NOT INCLUDE MOLD PROTRUSIONS. MOLD PROTRUSIONS NOT TO EXCEED 0.25 [.010].
- ⑦** DIMENSION IS THE LENGTH OF LEAD FOR SOLDERING TO A SUBSTRATE.

FOOTPRINT

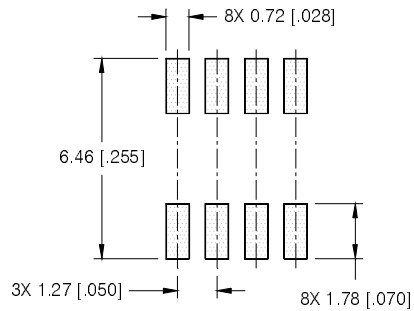

SO-8 Part Marking

EXAMPLE: THIS IS AN IRF7101 (MOSFET)

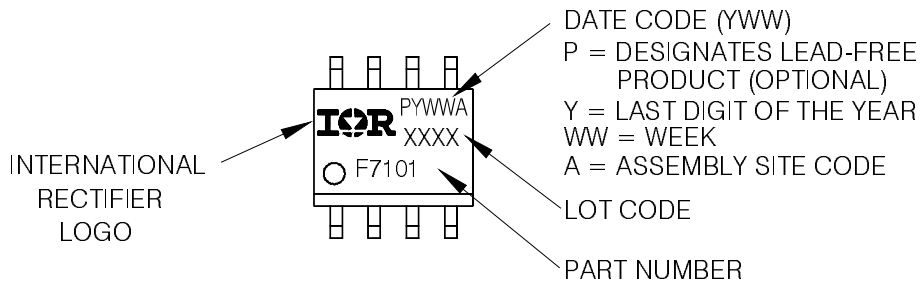

SO-8 Tape and Reel

Dimensions are shown in millimeters (inches)

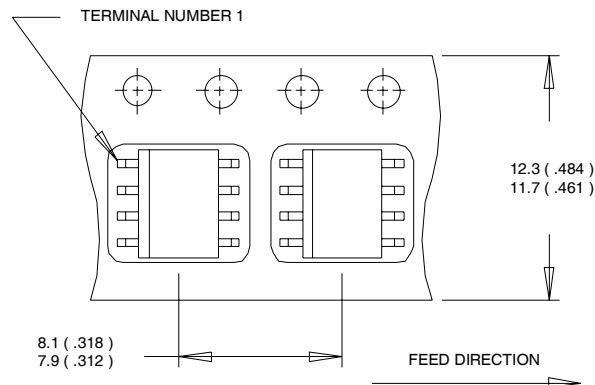

NOTES:

1. CONTROLLING DIMENSION : MILLIMETER.
2. ALL DIMENSIONS ARE SHOWN IN MILLIMETERS(INCHES).
3. OUTLINE CONFORMS TO EIA-481 & EIA-541.

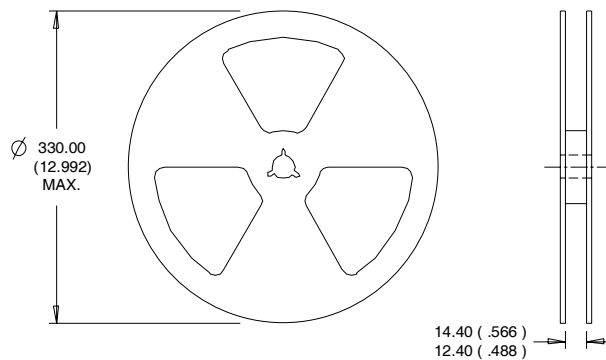

NOTES :

1. CONTROLLING DIMENSION : MILLIMETER.
2. OUTLINE CONFORMS TO EIA-481 & EIA-541.

Note: For the most current drawing please refer to IR website at <http://www.irf.com/package/>

Data and specifications subject to change without notice.

This product has been designed and qualified for the Automotive [Q101] market.

Qualification Standards can be found on IR's Web site.